



9" Widescreen Digital LCD Television with FM Radio and USB/SD/MMC Inputs

MODEL NO.:NT-9567



Instruction Manual



BEFORE USING THIS PRODUCT, READ, UNDERSTAND
AND FOLLOW THESE INSTRUCTIONS.
Save this booklet for future reference.

TABLE OF CONTENTS

GETTING STARTED:

IMPORTANT INSTRUCTION.....	2-3
FEATURES.....	4
ACCESSORIES	4
GENERAL PARTS.....	5
REMOTE CONTROL.....	6
BASIC CONNECTION.....	7
INSTALL BATTERY.....	7-8
REMOTE CONTROL PREPARATION.....	9

OPERATIONS:

MAIN MENU.....	10-24
SLIDESHOW.....	10-11
MUSIC.....	11
VIDEO.....	11-12
BROWSE.....	12-13
DTV.....	13-22
FM RADIO.....	23
SETTINGS.....	23-24

FOR REFERENCE:

TROUBLESHOOTING.....	25
MAINTENANCE.....	26
SPECIFICATIONS.....	26

MAINTENANCE

- Be sure to press POWER button to set the player to the standby mode and disconnect the AC adaptor before maintaining the player.
- Wipe the player with a dry, soft cloth.
- If the surfaces are extremely dirty ,wipe clean with a cloth which has been dipped in a weak soap-and-water solution and wrung out thoroughly, and then wipe again with a dry cloth.
- Never use alcohol, benzine, thinner, cleaning fluid or other chemicals. And do not use compressed air to remove dust.

SPECIFICATIONS

- 1.Earphone Output : $\leq 3\text{mW}$
- 2.Display device: Color TFT LCD
- 3.Display Screen Size: 9 inches
- 4.Input Resistance : $75\ \Omega$
- 5.Power Consumption: $\leq 10\text{W}$
- 6.Resolution: 640RGB (H)*234 (V)
- 7.Dots Distance: 0.30975(H) X 0.4775(V)mm
- 8.Visible Range: 198.240(H) X111.735(V)mm
- 9.Power Source: AC adaptor (normal: DC 5V $\overline{\text{---}}$)
- 10.Operation Temperature : -5°C to $+45^{\circ}\text{C}$.
- 11.FM Frequency Range:87.5~108MHz
- 12.Measurement: 238(L) X 180(W) X29.5(D) mm
- 13.Weight: Approx. g

Specifications are subject to change without notice.

GENERAL TROUBLESHOOTING

Check the following points before assuming malfunctions of the TV set:

Phenomenon	Reasons
No picture&sound	Improper connection of AC adapter or the battery power is not enough.
No picture	TV reception channel is not right and try to reset the unit. Relocate the TV set to the place where reception is better or select the sound key.
No sound	Volume is too low, mute function is switched in. The headphone has been plugged in or the signal is too weak.
Poor reception	TV antenna is not correctly adjusted or TV channel is not right.
Dark or blurred picture	The bright & contrast is too low. The battery voltage is too low.
Unclear or unstable picture	TV antenna is not properly adjusted or in too weak signal reception area.
Picture moves up & down, blurs or folds over	TV antenna is not rightly adjusted. The signal reception is too weak or caused by signal reflection from the buildings nearby or mountains.
Interfered snow picture	The signal is interfered by car's engine, railway, high tension wires, neon signs or radio frequency.
No color	Color or color system is not set properly.
FM has no sound	Insert the earphone in the phone jack

IMPORTANT INSTRUCTIONS

SAFETY INSTRUCTIONS

WARNING -- TO REDUCE THE RISK OF FIRE, ELECTRIC SHOCK, OR SERIOUS PERSONAL INJURY:

- Do not use this product near water; e.g. near a bathtub, washbowl, kitchen sink, laundry tub, in a wet basement, near a swimming pool, or the like.
- Situate this product away from heat sources such as radiators, heat registers, stoves, or other appliances (including amplifiers) that produce heat.
- Clean the product only as recommended by the manufacturer (see the "Maintenance" section for details). Unplug the power cord from the wall outlet before cleaning.
- Unplug the power cord from the wall outlet when left unused for an extended period.
- Take care that objects do not fall and liquids are not spilled into the product case through product openings.
- Operate the product only with the supplied power adapter. Route power cords so they are not likely to be walked on or pinched by items placed upon or against them, paying particular attention to cords at plugs, convenience receptacles, and the point where they exit from the product.
- Do not operate this product under the following conditions:
 - When the power-supply cord or plug is damaged.
 - If liquid has been spilled into or objects have fallen into the product.
 - If the product has been exposed to rain or water.
 - If the product does not operate when used according to the operating instructions.
 - If the product has been dropped or damaged in any way.
- Do not attempt to service the product; take it to the electronics repair shop of your choice for any servicing or repair.
- Do not overload wall outlets, extension cords, or integral convenience receptacles.

⚠ CAUTION-- TO REDUCE THE RISK OF PERSONAL INJURY OR PRODUCT/PROPERTY DAMAGE:

- This product is intended solely for non-commercial, non-industrial, personal use as a portable television. Do not use this product for any other purpose.
- Do not subject the product to violent shocks, extreme temperatures, or lengthy periods of direct sunlight.
- Keep the product away from magnetic objects, motors, and transformers.
- Do not use outdoors in inclement weather.
- Do not wall or ceiling-mount this product.
- Do not remove the protective wrapping from the Rechargeable Battery Pack.
- Do not use the TV while driving; this is dangerous and is illegal in some areas.

BATTERY HANDLING AND USAGE:

- KEEP BATTERIES AWAY FROM CHILDREN AND PETS. ONLY ADULTS SHOULD HANDLE BATTERIES. DO NOT ALLOW A CHILD TO HANDLE THIS PRODUCT UNLESS THE BATTERY COMPARTMENT COVER IS SECURELY ATTACHED TO THE BATTERY COMPARTMENT IN ACCORDANCE WITH ALL PRODUCT USAGE INSTRUCTIONS.
- NEVER THROW BATTERIES INTO A FIRE OR EXPOSE THEM TO FIRE OR OTHER HEAT SOURCES.
- FOLLOW THE BATTERY MANUFACTURER'S SAFETY AND USAGE INSTRUCTIONS.

7.1 LANGUAGE

This item is for setting the menu language. There are multi OSD languages: English and other languages. You can choose it as desired.

7.2 SET COLOR

7.2.1 Set Contrast

This item is used for adjusting the level of TFT Contrast. The level can be adjusted from 0 to 100.

7.2.2 Set Brightness

This item is used for adjusting the level of TFT Brightness. The level can be adjusted from 0 to 100.

7.2.3 Set Saturation

This item is used for adjusting the level of TFT Saturation. The level can be adjusted from 0 to 100.

7.3 SET MENU

7.3.1 Menu Rise Effect

This item is used for setting the menu rise effect, you can choose: Straight style and Whirl style.

7.3.2 Menu View

This item is used for setting the menu view mode, you can choose: Looking Straight, Over Looking and Looking up.

7.4 SET SLIDESHOW

7.4.1 Transition Effect

This item is used for setting the picture slideshow transition effect, you can choose what you like.

7.4.2 Duration

This item is used for setting the picture slideshow duration time, you can choose: Fast(1 Sec), Normal(10 Sec)and Slow(100 Sec).

7.5 SET FM RADIO

7.5.1 FM Light Auto Off

This item is used for setting the screen of unit automatically power off time when playing FM radio Press UP/DOWN button to select and use AUTO/OK button to confirm.

-Option: Off/10 Seconds/20 Seconds/30 Seconds.

NOTE: When the set time elapses, the screen will power down and will reactivate when any button is pressed.

7.6 INFO

This item is display the information about the unit.

7.7 RESET

This item is used to restore original factory settings. Press AUTO/OK or RIGHT button to enter. Then press LEFT or RIGHT button to select YES or NO.

-YES:is to restore original factory settings.

-NO:is to cancel.

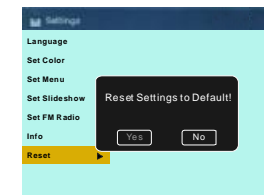

6.MAIN MENU-FM RADIO

Note: Before entering into the FM RADIO, please insert the earphone to the phone jack first. ("Please Insert Earphone" will appear on the LCD screen until insert the earphone in the phone jack.)

When using the earphone, do not set the volume too loud, that may damage your ear. You must scan channel before the first using, or there is no channel play.

The screen will shut off after a certain time (it depends on the setup of SET FM RADIO in SETTINGS) of inactivity to help conserve battery power and will reactivate when any button is pressed.

When in main menu page, press LEFT or RIGHT button to select FM RADIO item and press AUTO/OK or ENTER button to enter, then screen will display as follows:(You can also press SWITCH button to select the unit in FM RADIO mode)

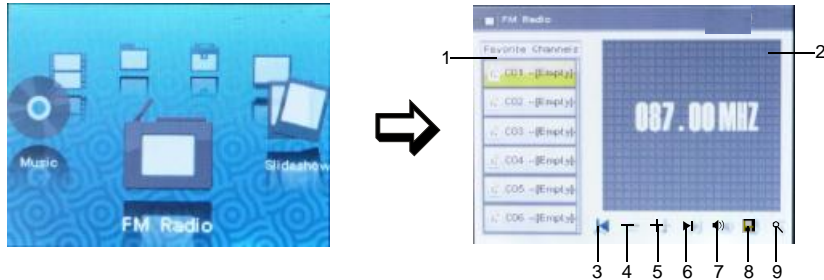

Press CH-/▼ or CH+/▲ button to select the desired item and press AUTO/OK or ENTER button to confirm.

1. LEFT WINDOW-To store your favorite channels.
2. RIGHT WINDOW-In playing mode, it will display the FM frequency. And in auto search channels mode, it will display the channel list that the channels are searched.
3. ◀ button-Auto search the backward channel.
4. - Button-Decreases FM frequency by 0.1 MHz with each press.
5. + Button-Increases FM frequency by 0.1 MHz with each press.
6. ▶ button-Auto search the forward channel.
7. Volume button-To adjust the volume level. Use LEFT/RIGHT button to select this item, press AUTO/OK or ENTER enter into this item, then press LEFT/RIGHT button to adjust the level and press AUTO/OK or ENTER button to confirm your operation.
8. 📁 button-Press this button to update the favorite channel list.
9. 🔍 button-Press this button to automatically search all the channels, the searched channels will display in the right window.

7.MAIN MENU-SETTINGS

-Press LEFT/RIGHT button to select SETTINGS item, then press AUTO/OK or ENTER button to confirm, the screen will display as following:

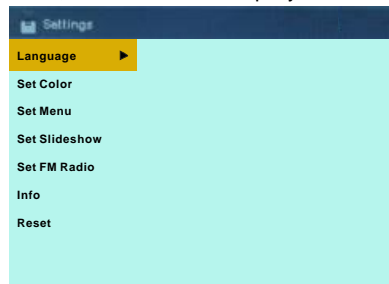

-Press UP/DOWN button to select submenus, then press AUTO/OK or RIGHT button to enter the submenu. Press UP/DOWN button to select the desired option and press AUTO/OK or ENTER button to confirm.
-Press LEFT or MENU button to return to a previous menu.

FEATURES

9" TFT DISPLAY

This player has a built-in 9" TFT display window, to provide clear vision, and low radiation.

AUTO TV SCANNING FUNCTION

WITH RECHARGEABLE LITHIUM BATTERY

MEMORY FUNCTION

DIGITAL BROADCASTING RECEPTION

SUPPORTING CURRENT DAYS ELECTRIC PROGRAM GUIDE

MULTI-SUBTITLES FUNCTION(OSD)

Subtitles may be displayed in one of a multi-language depending on the software.

GUIDE DISPLAY LETS OPERATION MORE EASILY

SUPPORT FULL FUNCTION REMOTE CONTROL

SUPPORT USB AND SD/MMC/MS CARD READER

BUILT-IN STAND HOLDER

SUPPORT FM RADIO FUNCTION

ACCESSORIES

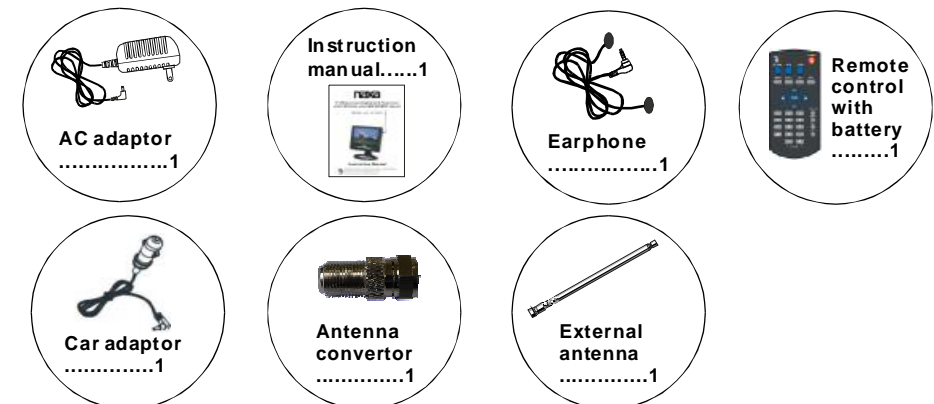

All the pictures in the instruction manual are just for your reference, specification should refer to actual accessories.

GENERAL PARTS

MAIN UNIT



1. **TFT DISPLAY WINDOW**
 2. **Built-in speaker**
 3. **Power indicator/Charge indicator**
 4. **MENU Button**-To enter DTV menu setting page(in DTV mode).
 5. **CH-/▼ Button**-To select previous channel/file or move down.
 6. **CH+/▲ Button**-To select next channel/file or move up.
 7. **AUTO/OK Button**-To enter into the auto scan menu (in DTV mode) or confirm a selection.
 8. **VOL-/▼Button**-To adjust the volume lower or move left.
 9. **VOL+/▲Button**-To adjust the volume louder or move right.
 10. **SWITCH Button**-Press this button to switch the unit in MAIN MENU page,DTV or FM Radio.
 11. **Remote control sensor**
 12. **RF IN jack**
 13. **MINI USB slot**
 14. **SD/MMC/MS card slot**
 15. **Phone jack**-Connect to headphone for private listening.
 16. **POWER ON/OFF SWITCH**
 17. **DC 5V IN**
-
18. **With telescoping antenna**
 19. **Battery cover**
 20. **Stand holder**

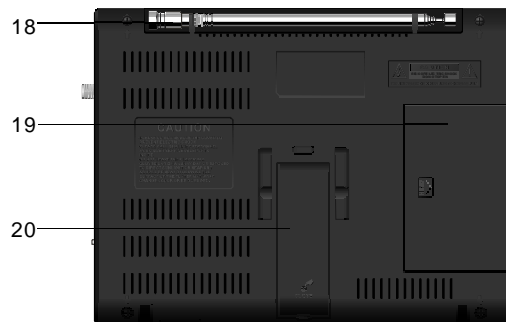

Channel NO.

It is used to swap settings between two channels.

- Press up or down button to select it.
- Press the left button to swap the current channel number with the previous channel's.
- Press the right button to swap the current channel number with the next channel's.

Channel Label

-It is used to set the channel label as desired.

- Press up or down button to select and press AUTO/OK to enter:

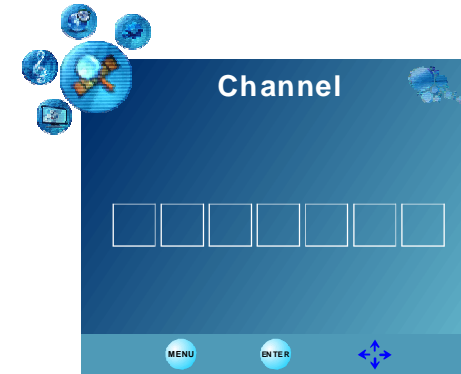

- Press up or down button to input symbol or letter as desired.
- Press left or right button to enter the previous or next item.
- Then the label will display on the screen under channel number.

DTV Signal

-It is used to display the intensity of the digital TV signal.

5.CHANNEL

Press left or right button to enter this page:



Air/Cable

It is used to set the type of signal reception.

-Press up or down button to select it and then press left or right button to set.
-Options: Air /Cable.

Auto Scan

Before normal watching you must search effective channel first.

-Press up or down button to select it and press AUTO/OK or RIGHT button to get in.



Show/Hide

It is used to show or hide the channel.

-Press up or down button to select it and press AUTO/OK to show/hide page:



-Press AUTO/OK to select show or hide the program.

-Press MENU to exit this page.

REMOTE CONTROL

1. **MUTE** -To mute the sound.
2. **PICTURE**-Press this button to select the picture display effect between dynamic, soft, personal or standard.
3. **MENU**-Display the main menu . Press it can also return to previous menu in menu setup page.
4. **SLEEP**-To set the sleep time. (The TV will be in standby mode automatically in a period of time you set.)
5. **LEFT button**-To move left.
6. **NUMERRIC BUTTONS**-To input the numeric information, such as channel number and so on.
7. **↵Button**-Press this button to go to previously selected channel.
8. **VOLUME - button** -To aadjust volume lower.
9. **POWER button** -To set the TV in standby mode; press it again to switch it on.
10. **MTS**-To change the soundtrack .
11. **ZOOM button**-Used to select the desired display mode wide or normal.
12. **EXIT**-To exit the menu page.
13. **EPG**-Display the program information of current day or latter days.
14. **UP button**- To move up.
15. **ENTER button**-To confirm a selection or an operation.
16. **RIGHT button**- To move right.
17. **DOWN button**- To move down.
18. **SWITCH button**-To switch the unit in MAIN MENU page, DTV or FM radio mode.
19. **INFO**-To display current program information, such as channel number, soundtrack mode and so on.
20. **CH+**-To select program forward .
21. **CH-** -To select program backward.
22. **- BUTTON**-Used to directly input TV channels.
23. **VOLUME + Button**-To adjust volume louder.

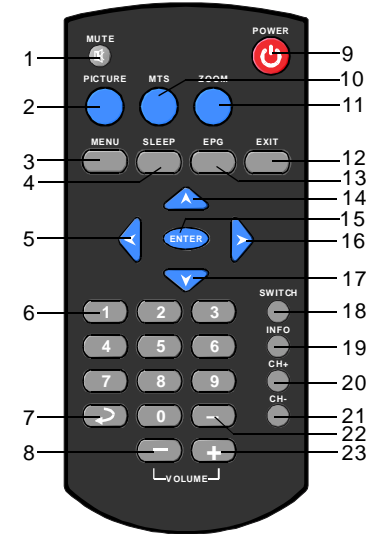

BASIC CONNECTION

- Ensure all the cables are disconnected from the main unit before connecting to AC power source by AC power adaptor.
- Read through the instructions before connecting other equipment.

CONNECTING TO AC POWER SOURCE

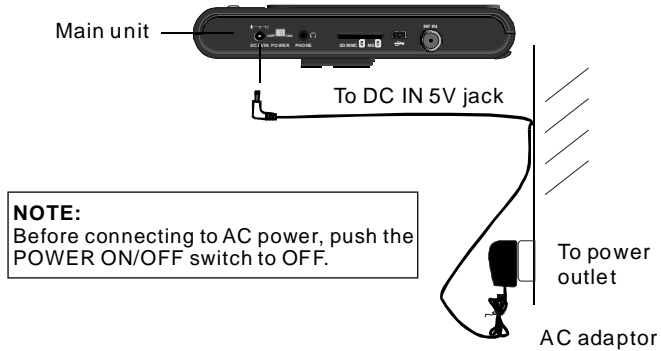

CONNECT EXTERNAL ANTENNA TO UNIT

Install external antenna into antenna jack for best picture.



INSTALL BATTERY

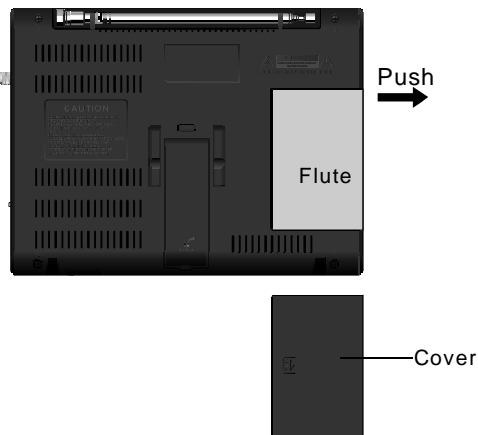

INSTALL BATTERY AS FOLLOWS:

1. Push the cover to open it.
2. Put the lithium battery in the flute.
3. Close the cover.

Note:

Before install the battery, please push the POWER button to turn the unit OFF. Make sure all the connectors are unconnected. When closing the cover, you should aim at the slot accurately.

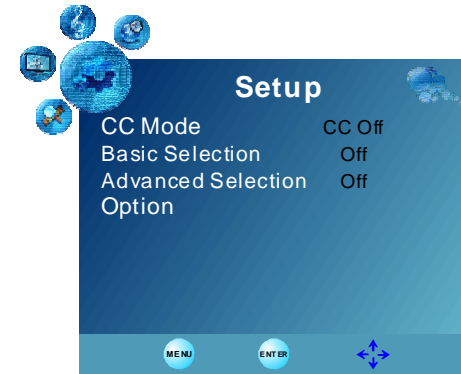

CC Mode-Press up or down button to select it and press left or right button to set the caption mode as CC Off/CC On/CC On Mute.

Basic Selection-Press up or down button to select it and press left or right button to set as desired.

Advanced Selection-Press up or down button to select it and press left or right button to set as desired.

Option-In this submenu, you can set items as desired.

Restore Default

-It is used to reset to factory settings.

-Press up or down button to select it and press AUTO/OK or RIGHT button to confirm, then the screen displays as below:



-Press left or right button to select YES or NO, and then press AUTO/OK button to confirm.

Return to MM

-It is used to return to MAIN MENU page.

-Press up or down button to select it and press AUTO/OK or RIGHT button to confirm.

Time Zone

-Press up or down button to select it and press left or right button to set the time zone according to the zone that you are in.
 -Options: Eastern/ Central/ Mountain/ Pacific/ Alaska/ Hawaii/Atlantic

DST

It is used to set daylight saving time(summer time)
 Press up or down button to select it and press left or right button to switch this function on or off.

Time Format

It is used to set the time format of clock.
 -Option:12-hour/24-hour

Clock

Shows date and time as broadcast by some TV stations (this option is not user adjustable)

4.SETUP

Press left or right button to enter this page:



Menu Language

-Press up or down button to select it and press left or right button to change the menu language.
 -Options: English or other languages. It depends on the software.

Transparent

It is used to change the menu transparency.
 -Option:0%/25%/50%/75%/100%

OSD Time Out

-Select it and press left or right button to set the OSD display time as 5/15/ 30/ 45/ 60 Seconds.

Closed Caption

-It is used to set the caption mode.
 -Press up or down button to select it and press AUTO/OK button to get in setting page:

RECHARGEABLE BATTERY USE

This player with a chargeable Lithium battery.

1.Charge the battery

Connect the adaptor to the DC 5V IN jack, the unit in ON mode(THE PLAYING MODE)for fully charge. Or you can set in the POWER OFF mode for fully charge.

2.Time to recharge the battery

Charge the built-in battery pack 8 hours before using the TV for the first time.
 Recharge and playback time depends on battery pack capacity and the temperature condition.
 Generally speaking, the battery needs to be charged about 5-7 hours.

3.Using and Maintaining Rechargeable Battery

The normal working condition temperature is: 0 ~45°C ;
 Always unplug AC/DC power supply for the unit whenever not playing.

NOTE :

A new battery pack which has not been used or one which has not been used for more than a month, may appear to not recharged enough , this is due to the characteristic of this battery and is not a malfunction. In this case, recharge it two or three times before the first use and it needs more than 8 hours to recharge battery.

Noises may be generated during recharging. In this case, use a more distant power socket.
 Do not recharge or discharge battery near a heating element such as a heater or direct sunlight.

When battery strength becomes low, the low battery icon will blink in the lower right corner of the LCD Screen(As the picture of follows:)

When the low battery icon appear, please charge the battery immediately.Otherwise,the TV will power down several seconds later.



Charge/Power Indicator Modes

The Charge/Power indicator light will illuminate differently depending on various operating modes, as shown below:

Color	Condition
Red	Power Cord connected, Power Switch set to OFF
Red indicator wink ceaselessly	Power Cord connected, Power Switch set to ON, TV on,Battery pack charging
Extinguish	Power Cord connected, Power Switch set to OFF, Battery full Power Cord disconnected, TV on(running on battery power) Power Cord connected, TV on, Battery full

REMOTE CONTROL PREPARATION

BATTERY INSTALLATION

Install the battery as the follow picture. Be sure negative and positive terminals are positioned as indicated in the battery compartment.(Fig1)

SERVICE LIFE OF BATTERIES

-The batteries normally last for about one year although this depends on how often, and for how often the remote control is used.

-If the remote control fails to work even when it is operated near the player, replace the batteries.

-Use two size AAA dry batteries.

Note:

- Do not drop, step on or otherwise impact the remote control. This may damage the parts or lead to malfunction.
- If the remote control is not going to be used for a long time, remove the batteries.

REMOTE CONTROL OPERATION

Point the remote control from no more than about 6 m from the remote control sensor and within about 60° of the front of the player(Fig2).

NOTE:

- The operating distance may vary according to the brightness of the room.
- Do not point bright lights at remote control sensor.
- Do not place objects between the remote control and the remote control sensor.
- Do not use this remote control while simultaneously operating the remote control of any other equipment.

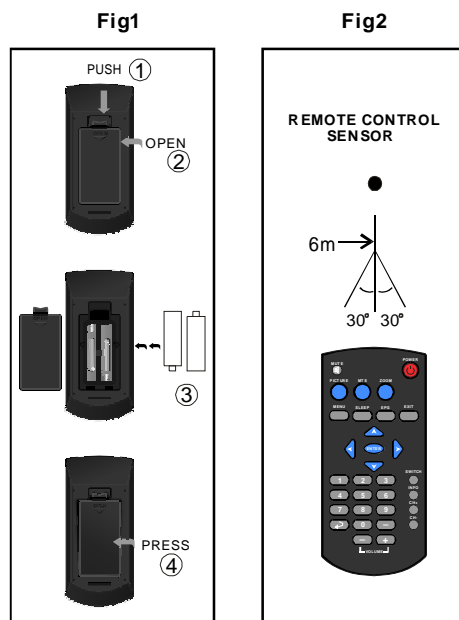

2.AUDIO

Press left or right button to enter audio setup page:

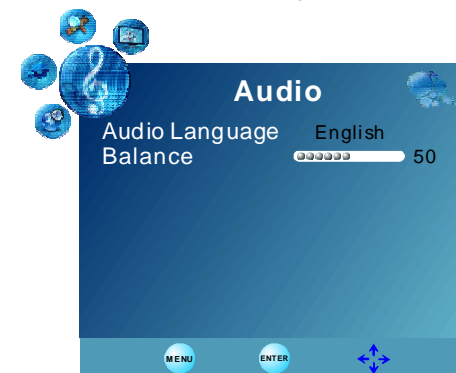

Audio language

Press up or down button to select it ,then press left or right button to change the language what you want. In this unit, you can select English or other languages.

Balance

-The Balance can be adjusted from 0 to 100.

3.TIME

Press left or right button to enter time setup page:

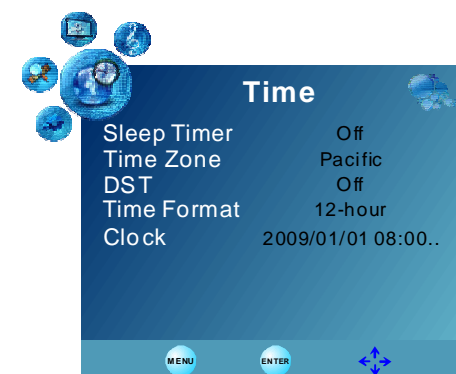

Sleep Timer

-Select it and press left or right button to switch the timer function off or set different sleep time.
-The sleep time can be set as 5/10/15/30/45/60/90/120/180/240 Min. By pressing left or right button.(The TV will be in standby mode automatically in a period of time you set. And when the time left is less than 1 minute, there will spring a dialog window to show count down and remind you.)

59 sec . TO POWER OFF

1. PICTURE

-Press the **MENU** button the screen will display:



Picture mode

Press up or down button to select it, then press left or right button to set the picture mode: Personal/Standard/Dynamic/Soft.

Contrast/Brightness/Sharpness/Tint/Color

-Press up or down button to select Contrast/Brightness/Sharpness/Tint/Color, then press left or right button to adjust.

-The level can be adjusted from 0-100.

Color mode

-Press up or down button to select it and press left or right button to change the color mode.

-Options: Personal/Normal/Warm/Cool.

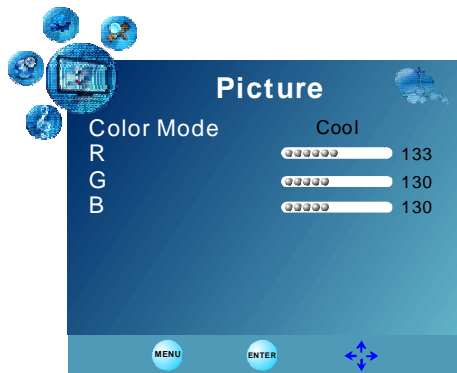

Zoom mode

-Press up or down button to select it and press left or right button to change the zoom mode.

-Options: Normal/Wide

MAKE SURE ALL THE EQUIPMENTS AND AC ADAPTOR ARE CONNECTED PROPERLY AND THE UNIT IS SET IN CORRECT MODE BEFORE KINDS OF OPERATIONS.

OPERATIONS



Turn on the unit then you can select desired function to get in, there are eight functions consist of **Slideshow, DTV, FM Radio, Settings, Browse, Video and Music.** (Note: If there is no card/USB in the unit, the Slideshow, Browse, Video and Music have no function.) Press UP/DOWN button to switch the main menu display style. You can press LEFT/RIGHT button to select your favorite function, then press AUTO/OK or ENTER button to go into it. And you can press MENU button to return to previous menu page.

Press SWITCH button to select the unit in MAIN MENU page, DTV or FM radio mode.

1. MAIN MENU-SLIDESHOW

Insert card(SD/MMC/MS) or USB into the card/USB slot, then select the SLIDESHOW item in the main menu, press AUTO/OK or ENTER button to confirm. Then press navigation buttons to select desired file and press AUTO/OK or ENTER button to confirm.

The media format which unit support consists of:

Content	file format
Slideshow	JPEG/BMP/GIF
Music	MP3/WMA
Video	DAT/MPEG/AVI

SLIDESHOW



-In the SLIDESHOW item, it supports play picture and background music synchronously.

-Press MENU button the screen will display as shown (left picture):

Press VOL-/VOL+ button to select and press AUTO/OK or ENTER button to confirm.

1. To exit the slideshow item and return to MAIN MENU page.

2. To display the information of picture you select.

-Press LEFT/RIGHT button to select file as you desired and press AUTO/OK or ENTER button to slideshow pictures. Press UP/DOWN button to select slideshow mode as desired; press LEFT/RIGHT button to play the previous or next picture.

-When playing the picture, press AUTO/OK button the screen will display as following:

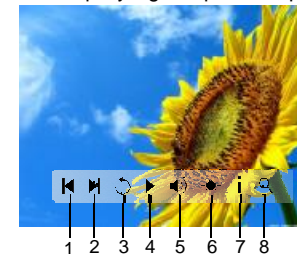

-Press LEFT or RIGHT button to select the item and press AUTO/OK button to confirm.
-Press MENU button to exit.

1. ⏪: To play the previous file.
2. ⏩: To play the next file.
3. 🔄: To rotate one picture clockwise by 90°.
4. ⏸: To play the file or pause the file.
5. 🔊: To adjust the volume level as desired and the level can be adjusted from 0 to 100. Press LEFT/RIGHT button to select this item and press AUTO/OK button to confirm, then press LEFT/RIGHT button to adjust and press AUTO/OK button to confirm.
6. ☀: To adjust the brightness as desired and the level can be adjusted from 0 to 100. Press LEFT/RIGHT button to select this item and press AUTO/OK button to confirm, then press LEFT/RIGHT button to adjust and press AUTO/OK button to confirm.
7. ⓘ: To display the information of picture you select.
8. 🔍: To zoom the picture in x1, x2, x4, x8 and press navigation button to see other portions of the picture.
Press MENU button to exit.

2.MAIN MENU-MUSIC

Select the MUSIC item in the main menu, press AUTO/OK or ENTER button to confirm. Then press UP/DOWN button to select desired file and press AUTO/OK or ENTER button to confirm. -In the MUSIC item, it only supports music playing and the format is MP3/WMA.

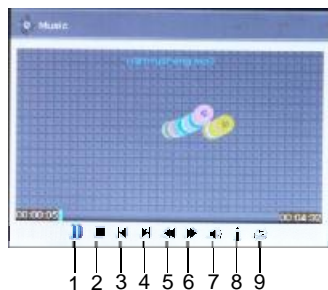

- Press LEFT or RIGHT button to select the item and press AUTO/OK button to confirm.
- Press MENU button to exit.

1. ⏸: To play or pause the file.
2. 📄: To return to the play list page.
3. ⏪: To play the previous file.
4. ⏩: To play the next file.
5. ⏮: To fast forward playing file by 10 seconds with each press.
6. ⏭: To fast rewind playing file by 10 seconds with each press.
7. 🔊: To adjust the volume level as desired and the level can be adjusted from 0 to 100. Press LEFT/RIGHT button to select this item and press AUTO/OK button to confirm, then press LEFT/RIGHT button to adjust and press AUTO/OK button to confirm.
8. ⓘ: To display the information of file you select.
9. 🔄: To select file repeat mode, there are four mode for your selection, you can select as desired.

3.MAIN MENU-VIDEO

Select the VIDEO item in the main menu, press AUTO/OK button to confirm. Then press UP/DOWN buttons to select desired file and press AUTO/OK button to confirm. -In the VIDEO item, it only supports video playing and the format is DAT/MPEG/AVI.

INFO(INFORMATION)

It is used to display current program information.

-Press INFO button, the screen will display as below:

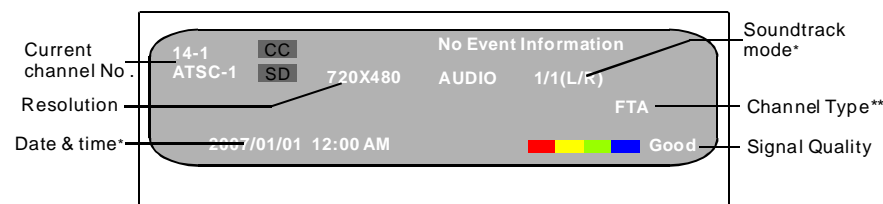

* Digital Channels Only

** Indicates free-to-air (FTA) or subscription channel

EPG (ELECTRONIC PROGRAM GUIDE)

It shows you the program guide for the current and future.

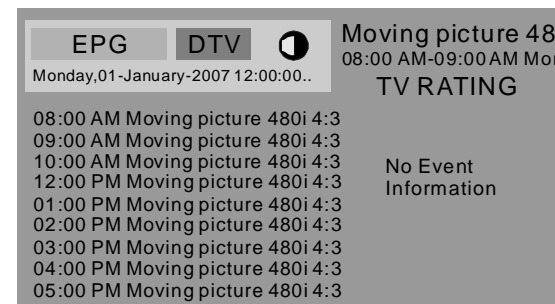

When viewing a digital channel, press the EPG Button to access the program guide supplied by the signal provider (not available in all areas). Information in the EPG includes current and future program titles, dates, show lengths, and episode summaries.

3.TV MAIN MENU

- The unit contains different setting menus. Once the initial programming is entered it is retained memory until changed, the TV can always be operated under the same conditions.
- The settings will be retained in the memory until the settings are changed even after setting the player to the standby mode.

Common procedure for initial settings

1.Press MENU button to display the setup menu.

2.Use the ⏪ and ⏩ buttons to select submenus, then press the ▼ or ▲ button to enter the submenu. Press the ⏪ and ⏩ buttons to select the desired option and press AUTO/OK to confirm.

3.Press the MENU button again to return to a previous menu.

4.Press EXIT button to close the setting menu.

- Keep pressing this button to select different mode.
- The picture mode can be adjusted as Standard, Dynamic, Soft and Personal.

MTS (SOUNDTRACK MODE)

It is used to change the audio output language.

- Press MTS button to enter audio language selection mode :

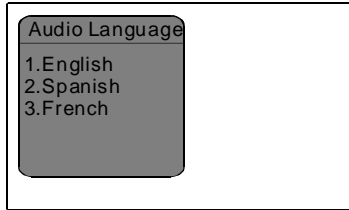

- Press UP or DOWN button to select the audio language as desired and the audio languages supplied by the signal provider (not available in all channels)

TIMER SETTING

- Press the SLEEP button, the screen display as below:



- Keep pressing this button to select different time.
- The sleep time can be set as Off/5/10/15/30/45/60/90/120/180/240 Min. (The TV will be in standby mode automatically in a period of time you set.)

ZOOM

It is used to change the display proportion.

- Press ZOOM button to change the display mode.



- The display proportion can be adjusted between Wide and Normal mode.

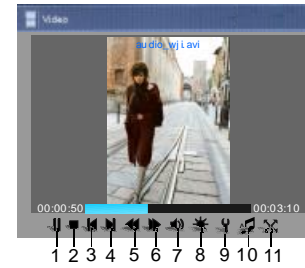

-Press LEFT or RIGHT button to select the item and press AUTO/OK button to confirm.
-Press MENU button to exit.

1. || : To play or pause the file.
2. ■ : To return to the play list page.
3. ◀ : To play the previous file.
4. ▶ : To play the next file.
5. ⏩ : To fast forward playing file by 10 seconds with each press.
6. ⏮ : To fast rewind playing file by 10 seconds with each press.
7. 🔊 : To adjust the volume level as desired and the level can be adjusted from 0 to 100. Press LEFT/RIGHT button to select this item and press AUTO/OK or ENTER button to confirm, then press LEFT/RIGHT button to adjust and press AUTO/OK or ENTER button to confirm.
8. ✨ : To adjust the brightness as desired and the level can be adjusted from 0 to 100.
9. 🗣️ : To switch the subtitle language of file. (This item works only with files on which multiple subtitle languages are recorded)
10. 🎧 : To switch the audio soundtrack mode of file, such as mono left, mono right or stereo.
11. 🖥️ : To switch the unit to full screen playing mode. Press LEFT/RIGHT button to select this item and press AUTO/OK or ENTER button to confirm to full screen playing mode, and press AUTO/OK or ENTER button again to return to previous mode.

4.MAIN MENU-BROWSE

Select the BROWSE item in the main menu, press AUTO/OK or ENTER button to confirm. Then press navigation buttons to select desired file and press AUTO/OK or ENTER button to confirm.

- In the BROWSE item, it supports play all format file which the unit support as desired.



When select picture file:

- Press AUTO/OK or ENTER button to play this file.
- Press MENU button the screen will display as shown(left picture): Press LEFT or RIGHT button to select and press AUTO/OK or ENTER button to confirm.
- 1. To exit the browse item and return to MAIN MENU page.
- 2. To set the picture what you select as startup screen logo.
- First, select the picture which you want to set, press MENU button.
- Then select icon 2 and press AUTO/OK or ENTER button, the screen will display as left picture shown.
- Press LEFT/RIGHT button to select YES or NO.
- Finally, press AUTO/OK or ENTER button to confirm that you can set the picture to be a logo or not.
- 3. To display the information of picture you select.

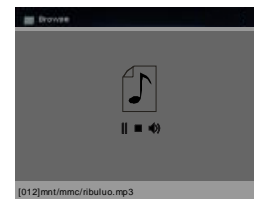
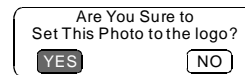

When select music file:

- 1) Press AUTO/OK or ENTER button to play this file. The screen will display as shown:
- Press LEFT or RIGHT button to select and press AUTO/OK or ENTER button to confirm.
- || - To play or pause the file.
- - To return to browse page.
- 🔊 - To adjust the volume level as desired and the level can be adjusted from 0 to 100.

Press LEFT/RIGHT button to select this item and press AUTO/OK or ENTER button to confirm, then press LEFT/RIGHT button to adjust and press AUTO/OK or ENTER button to confirm. Press MENU button to exit.

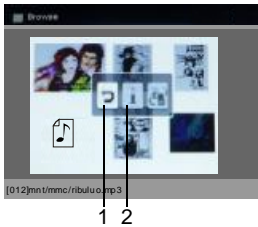

- 2) Press MENU button the screen will display as shown:
Press LEFT or RIGHT button to select and press AUTO/OK or ENTER button to confirm.
1. To exit the browse item and return to MAIN MENU page.
 2. To display the information of file you select.



When select video file:

- 1) Press AUTO/OK button to play this file. The screen will display as shown:
Press LEFT or RIGHT button to select and press AUTO/OK or ENTER button to confirm.

1. II : To play or pause the file.
2. ■ : To return to browse page.
3. 🔊 : To adjust the volume level as desired and the level can be adjusted from 0 to 100.

- Press LEFT/RIGHT button to select this item and press AUTO/OK or ENTER button to confirm, then press LEFT/RIGHT button to adjust and press AUTO/OK or ENTER button to confirm.
4. ⏩ : To fast forward playing file by 10 seconds with each press.
 5. ⏮ : To fast rewind playing file by 10 seconds with each press.



- 2) Press MENU button the screen will display as shown:
Press LEFT or RIGHT button to select and press AUTO/OK or ENTER button to confirm.
1. To exit the browse item and return to MAIN MENU page.
 2. To display the information of file you select.

5. MAIN MENU-DTV

When in main menu page, press LEFT or RIGHT button to select DTV item and press AUTO/OK or ENTER button to enter. (You can also press SWITCH button to select the unit in DTV mode)

1. SCAN SIGNAL

- Press AUTO/OK button to enter the following menu, then set the items as desired.

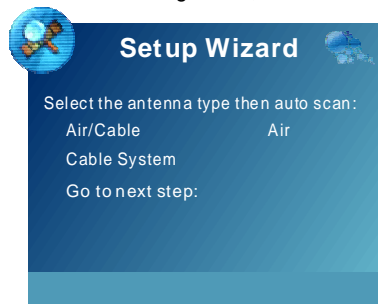

- Select <Go to next step>, use AUTO/OK or RIGHT button to confirm, then screen will display as:

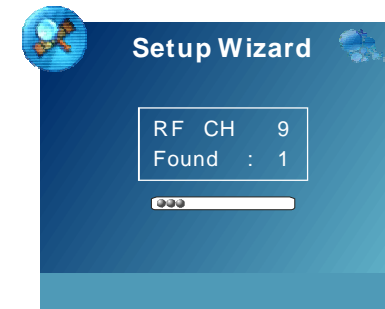

- Effective channel will be memorized automatically.
- Then the channel first stored will be played.

NOTE: 1. You must scan channel before the first watching, or there is no program shown.
2. You can press the MENU button on the unit or EXIT button on the remote control to exit the AUTO SCAN page.
3. Reception of TV signals depends on many factors; if the signal is weak, reception will be poor. For better reception, adjust the direction/position of the antenna or relocate the TV. After improving reception, repeat the Auto Scan process.

2. BASIC OPERATION

SELECT WANTED PROGRAM

1. Press CH + button to play next channel.
2. Press CH - button to play previous channel.
3. Press numeric buttons on the remote control directly to select program what you want.
Example: Track 9, press "9", three seconds later, it will automatically switch to track 9, or press ENTER button to confirm directly.
Track 12, press "1" and "2", three seconds later, it will automatically switch to track 12, or press ENTER button to confirm directly.

Note: If one frequency dot has more than one channel, for example, you want select <Ch14 NO.2>, Press 1 and 4, then press - and input 2. Once the input is done, it will start broadcasting the selected channel immediately.

VOLUME CONTROL

1. Press the VOL+ or VOL- to adjust the level of currently volume.
2. The level of VOLUME can be adjust from 0-30.

MUTE CONTROL

Press the Mute button to mute the sound, press it again to switch ON the sound.
NOTE: When the unit is in Mute mode, pressing VOL+ button will switch ON the sound and turn it up, pressing VOL- button will switch ON the sound and turn down the sound.

PICTURE MODE

- Press PICTURE button to enter picture mode :

